

# GLACIER BACKPLATE

INSTALLATION GUIDE V1.0  
PH-GB3090GBARSBP\_BK01/CR01

## GIGABYTE AORUS RTX 3090/3080

### PACKAGE CONTENTS

For latest version check [www.Phanteks.com](http://www.Phanteks.com)

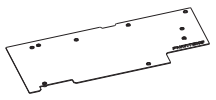

GLACIER BACKPLATE  
QTY: 1



M2.5x8 Flush Screws  
QTY: 9

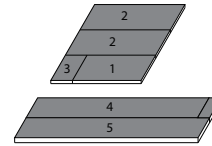

Thermal Pads  
QTY: 2

**⚠** This product requires the PH-GB3090GBARS GPU water block. Please follow step 1 to 3 of the GPU water block's installation guide before proceeding.

**⚠ WARNING** - This product is intended for advanced users. Improper installation may result in damage to your equipment. While all efforts have been made to provide the most comprehensive information possible, Phanteks assumes no liability expressed or implied for any damage(s) occurring to your components as a result of using Phanteks cooling products, either due to mistake or omission on our part in the below instructions, or due to failure or defect in the Phanteks cooling products. Do not disassemble the water block. Warranty will be voided.

Turn off the power to your system and discharge your body's static electric charge before proceeding with the installation procedure. If you do not feel comfortable with performing the installation procedure, consult a qualified computer technician.

### FINISH STEPS 1 TO 3 FROM THE WATER BLOCK INSTALLATION GUIDE BEFORE PROCEEDING:

#### STEP 4. APPLYING THERMAL PADS

Remove the protective film and place the thermal pads on the correct position on the backplate.

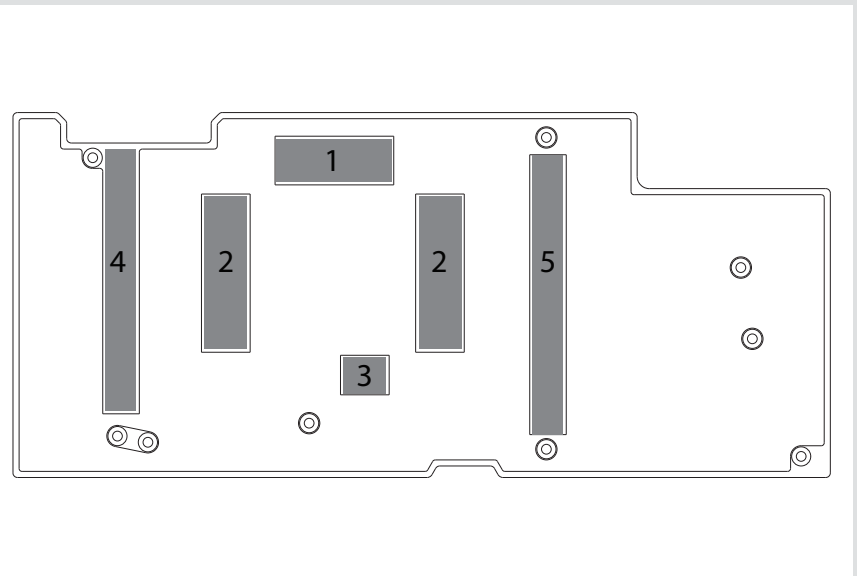
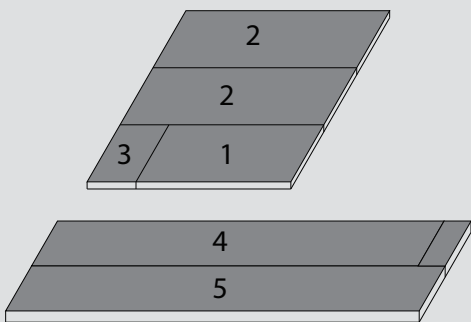

**⚠** Make sure to remove the protective film on both sides of the thermal pads.

## STEP 5. INSTALL THE GLACIER BACKPLATE

Carefully position the backplate onto the graphics card. Align the mounting holes on the PCB with the holes on the backplate.

Secure the backplate with 9 M2.5x8mm flush screws to the PCB.

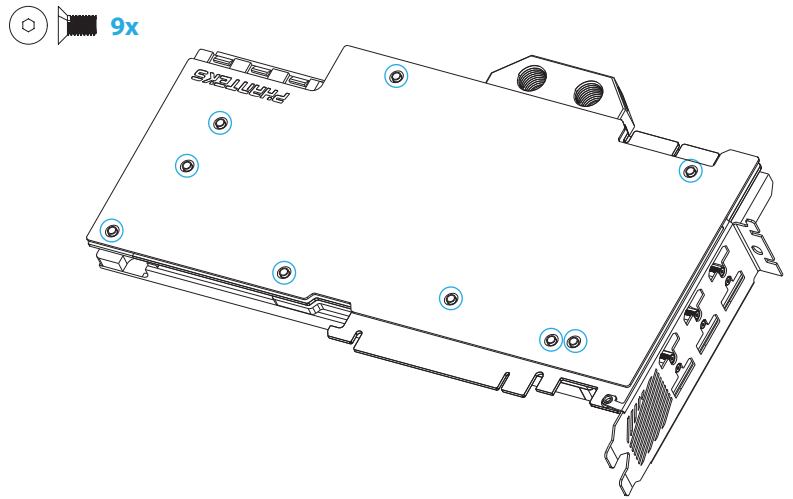

## STEP 6. CONNECT D-RGB LIGHTING

Connect the D-RGB cable to the D-RGB strip in the water block.

 All Phanteks D-RGB products can be daisy-chained together.

 You can connect the D-RGB cable to a compatible motherboard with the cable that is included with the motherboard.

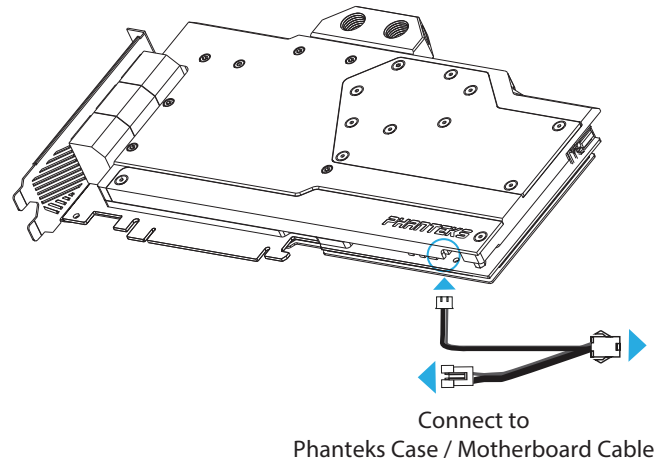

## STEP 7. INSTALLING FITTINGS

Install G1/4 threaded male fittings and close the remaining ports with the two included Stop Fittings.

 Always perform a leak test before providing power to any system components.

