

EVOLV SHIFT X

PHANTEKS
USER MANUAL

Thank you
for choosing

PHANTEKS

TABLE OF CONTENTS

■ 1. What's inside?

Specifications	3
Exploded view	4
Accessories	5

■ 2. Setup your system

Overview	6
Remove side panels	8
Cable management	9
Installing power supply	10
Adjust case feet	11
Installing motherboard	12
Installing cooling	13
Installing drives	14
Installing graphics card	16
Installing watercooling	18
Connecting front I/O	20

■ 3. Pro tips

Dust filters	21
Expand & upgrades	22

■ 4. Support

Contact us	23
Warranty	24



SPECIFICATIONS

CASE SPECIFICATIONS

Dimension (WxHxD)	170 mm x 650 mm x 274 mm 6.7 in x 26.1 in x 10.8 in
Height incl. Feet	663 mm (26.1 in)
Form Factor	Small Form Factor
Materials	Anodized aluminium panels Powder coated steel chassis Tempered glass side panels
MB Support	Mini ITX
PSU Support	SFX, SFX-L
Front I/O	2x USB 3.0, Power button, RGB button
Side Window	Yes, Tempered glass both sides

PCI SLOTS & DRIVE BAYS

PCI slots	2
Internal 3.5"	2x (if no radiator is installed)
Internal 2.5"	4x (2 included)

FAN	120 mm	140 mm
Front	3x	3x (1 installed)
Bottom	1x	1x (1 installed)

RADIATOR	120 mm	140 mm
Front	Up to 240	Up to 280
Bottom	120	-

INCLUDED ACCESSORIES

Premium fan 140 mm	2x
Power supply cover	1x
Pump bracket	1x
2.5" SSD bracket	2x
GPU bracket	1x
PCI-e x16 Risercable	1x
8-pin CPU Extension cable	1x

CLEARANCE

CPU Cooler	82 mm	(3.2 in)
Graphics card length	529 mm	(20.8 in)
Cable Management	27mm	(1.1 in)
Front Radiator	80mm	(3.1 in)

* Depending on GPU height/length.

SUPPORT

Contact (International)	support@phanteks.com
Contact (North and South America)	support@phanteksusa.com
Warranty	5 Years*

*see page 24

EXPLODED VIEW

1. Chassis
2. Front Panel
3. Rear Panel
4. Top Grill
5. Bottom Grill
6. Right Side Panel
7. Left Side Panel
8. GPU Bracket
9. Case Feet

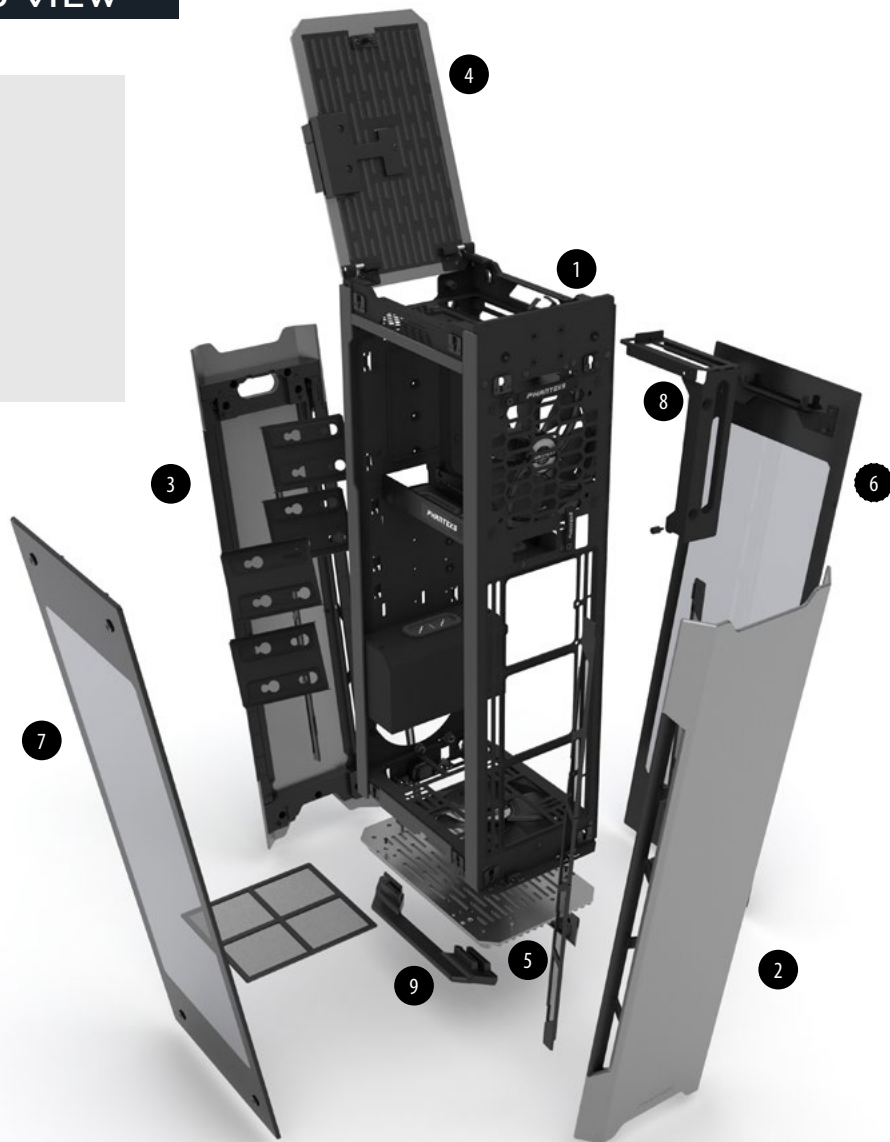

ACCESSORIES

2.5" SSD BRACKET

- 2 Pre-installed
- For 2.5" SSD



PREMIUM FAN 140 MM

- 2 Pre-installed
- High static pressure
- Silent operation



PUMP BRACKET







- 1 Included in accessory box
- Universal mounting holes
- Rubber dampening



ACCESSORY BAG

- 1x 8-pin CPU extension cable
- 6x Zip Tie 150 mm
- Phanteks Logo Badge
- 4x Rubber Feet (for horizontal placement)

TOOLBOX

<p>Fan screw</p>  <p>8x</p>	<p>M3x5 mm Motherboard /SSD</p>  <p>22x</p>	<p>6-32x6 mm PSU/GPU bracket</p>  <p>8x</p>	<p>6-32x5 mm Case / Pump bracket / HDD</p>  <p>14x</p>	<p>6-32x6 mm Thumb screw</p>  <p>1x</p>
<p>6-32x31 mm Radiator/fan screw</p>  <p>8x</p>				

OVERVIEW

The Evolv Shift X gives you the ultimate flexibility to place it anywhere in the house.

EASY ACCESS

Reach your best I/O with just a press

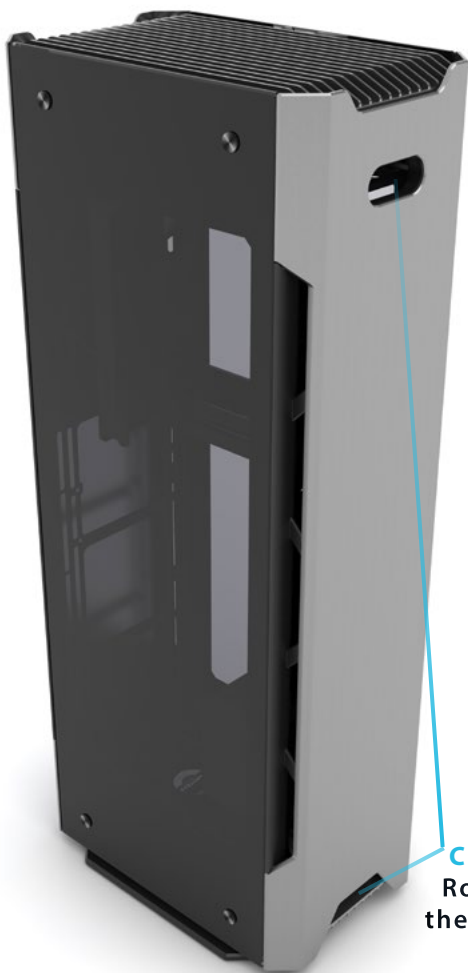

CABLE ROUTING
Route your cables through the top or bottom of the rear panel.

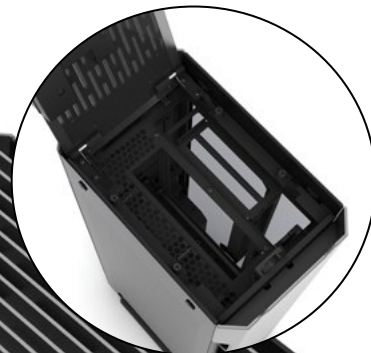

PLACE VERTICAL
Minimize the footprint.



PLACE HORIZONTAL
Use the rubber feet included
in the toolbox.



REMOVE SIDE PANELS

REQUIRE:



FIRST TIME USE

1. LOOSEN THUMB SCREWS

2. SLIDE SIDE PANEL UP

3. TAKE SIDE PANEL OUT



LOOSEN:

8 x



PRO TIP

Each panel is mounted securely with 4 slide to lock pins and 2 captive thumb screws. Removing all side panels gives you full 360 degree access to the whole system.



CABLE MANAGEMENT



MOTHERBOARD CABLE COVER
Flip open for easy access.

DEDICATED CABLE AREA
Bundle excess cables with velcro ties.

CLEAR OUT ZONE
Keep cables out of this zone for easy
panel installation.

INSTALLING POWERSUPPLY

- 1. REMOVE POWERSUPPLY COVER**
 - Remove two thumbscrews.
 - Slide the cover up to release.

REMOVE:

2 x



4 x



- 2. INSTALL POWERSUPPLY**
 - Pull off the bottom grill.
 - Install the powersupply.

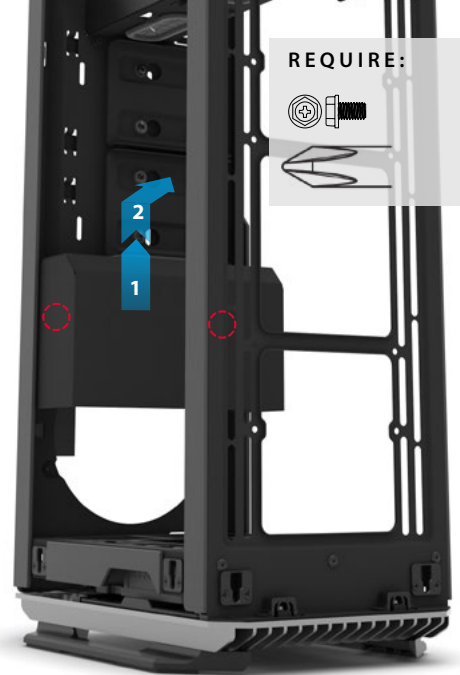

REQUIRE:



3.

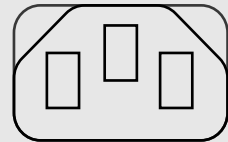

CONNECT POWER ADAPTER

 *Don't forget to turn on the power switch on your powersupply.*

ADJUST CASE FEET

REQUIRE:



VERTICAL

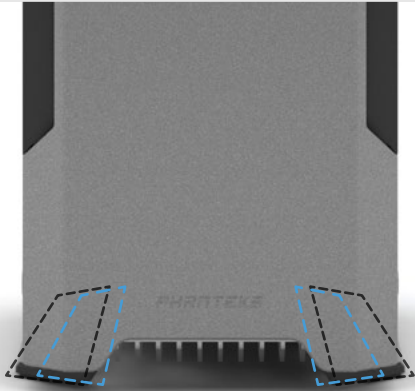

A. B. B. A.
CHANGE POSITION

HORIZONTAL

4x RUBBER FEET

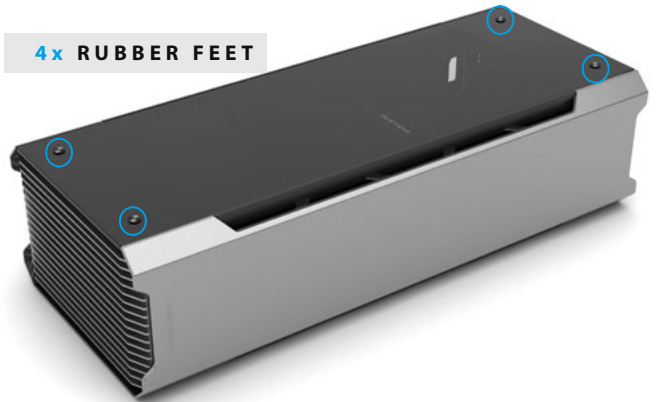

2X FOOT POSITIONS



REPOSITION:
4x



REMOVE FOOT



REMOVE:
4x



INSTALLING MOTHERBOARD

The motherboard is placed vertical with the rear I/O pointing upwards. Please consult your motherboard manual for more detailed instructions.



REQUIRE:

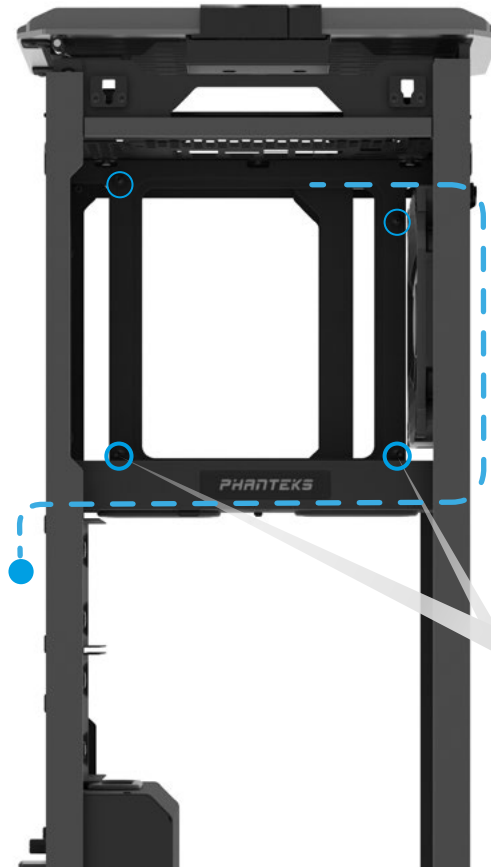
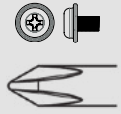

Keep cables clear from fan blades.



Use 8-pin extension cable if necessary.

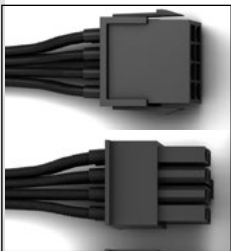

These standoffs have a special collar to keep the motherboard in place when installing vertically.



INSTALLING COOLING

REQUIRE:



FRONT

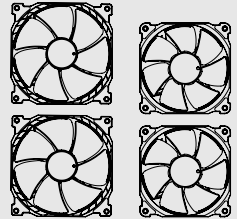
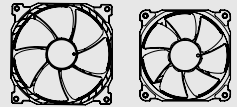

140
FAN

120
FAN

BOTTOM

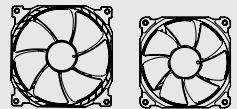

140
FAN

120
FAN



The Evolv Shift X was designed with water cooling in mind and therefore we recommend you to use water cooling for your CPU cooling for the best performance.



EVOLV SHIFT X

INSTALLING DRIVES

2.5" SSD INSTALLATION

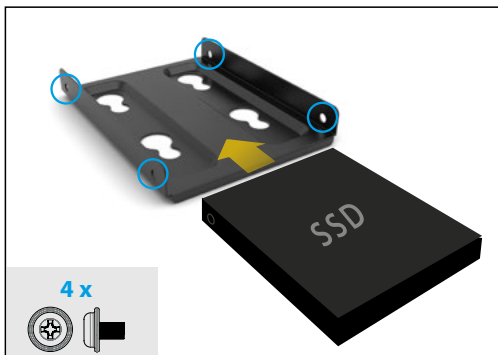



REQUIRE:



INTERNAL 3.5" HDD INSTALLATION



3.5" HDD's can't be installed if a radiator is installed here.

8 x



INSTALLING GRAPHICS CARD

1. PREPARE GPU BRACKET

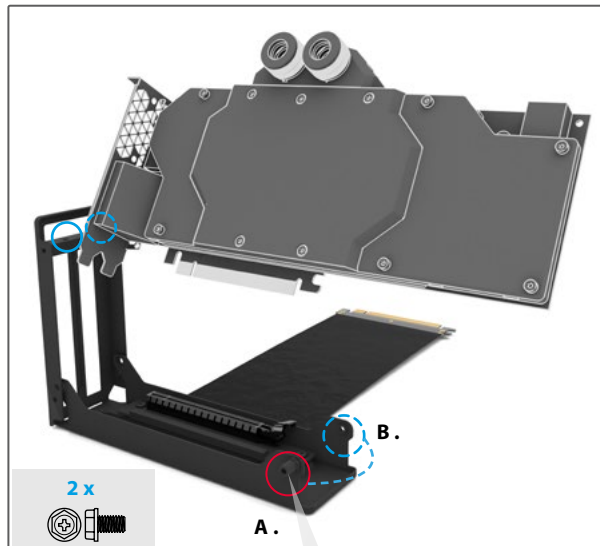

The GPU can be installed in 2x different orientations. Re-position the stand-off screw accordingly.

We recommend to:

A. Face cooler in for aircooled GPU.

B. Face cooler out for watercooled GPU.

REMOVE:

1 x

2 x



REQUIRE:

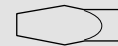

2. INSTALL GRAPHICS CARD

- 1 Slide GPU into the case
- 2 Secure with thumbscrew
- 3 Lock with case screws



PRO TIP

Slide the GPU bracket in the desired position with optimal clearance for your watercooling hardware, see page 18.

1 x



2 x



INSTALLING WATERCOOLING

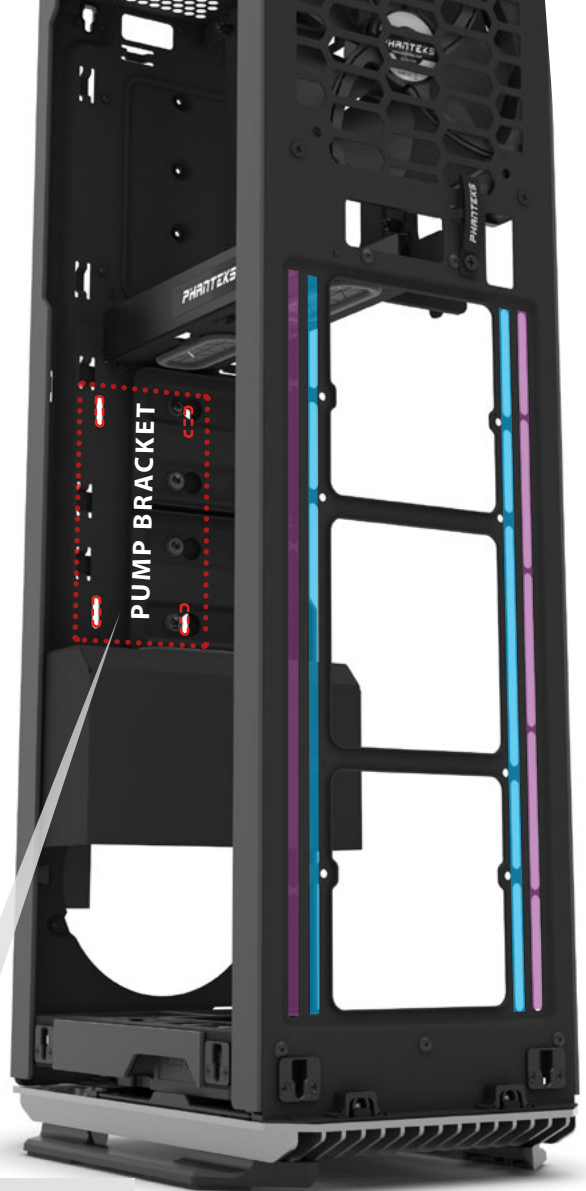
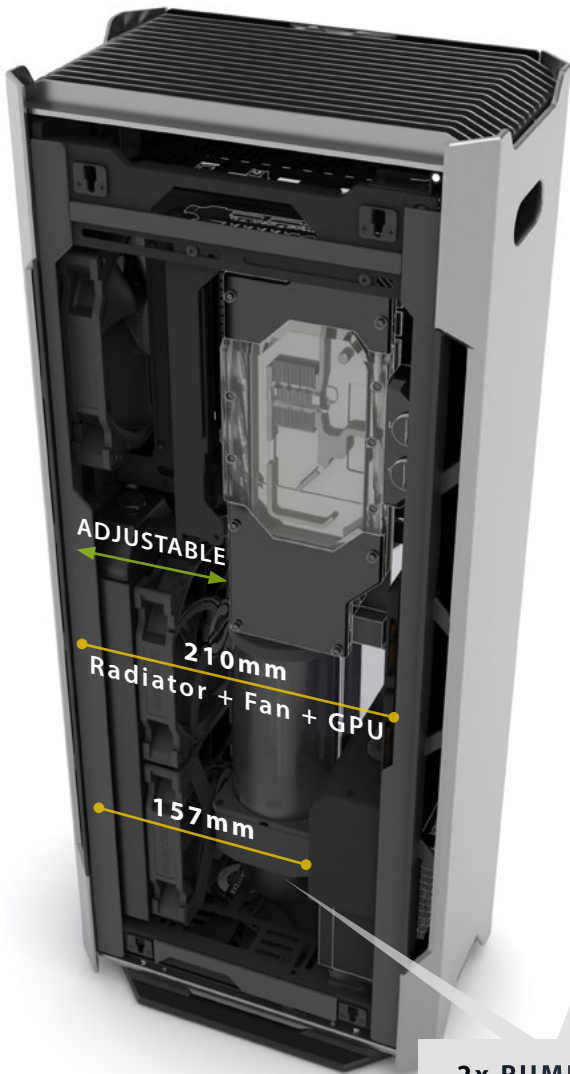

2x PUMP LOCATIONS

- 120 form factor
- 140 form factor

PUMP BRACKET MOUNTING HOLES:

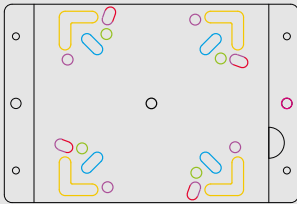

- Standard D5
- Swiftech MCP
- EKWB D5
- EHEIM
- DDC 42-50 mm
- 120 mm fan mount



Remove this panel to get better access to your water cooling hardware.
(GPU Block / Tubing / Fittings)



REQUIRE:



Please use the radiator screws that come with your radiator. When using the Phanteks radiator screws make sure the threading matches with your radiator's.



REMOVE:

4 x



CONNECTING FRONT I/O

POWER BUTTON

SHORT

Short Press: Turn on your system

HOLD

Press and hold: Turn off your system

RGB BUTTON

HOLD

Press and hold: LED On/Off

SHORT

Short Press: Choose LED Color (10 colors)

LONG

Long Press: Choose Mode

Mode 1: STATIC

Mode 2: BREATHING

Mode 3: COLOR CYCLE

TO MOTHERBOARD

Power SW

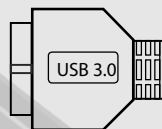

TO PSU

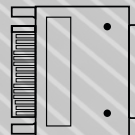

12V SATA input for
RGB controller

TO PHANTEKS RGB PRODUCTS



RGB connector
(expansion)

DUST FILTERS



We recommend to clean your filter once a month for optimal performance. Use running water to clean your filters and let it dry up before putting back to use.

EXPAND AND UPGRADE

2.5" SSD BRACKET

PH-SDBKT_01

The Shift X has place for an additional two SSD brackets.



PHANTEKS PH-F120MP / PH-F140MP

The Shift X supports up to 4 casefans.

- High static pressure
- Silent operation
- 120 mm and 140 mm sizes
- Available in Black or White



MORE RGB

The RGB controller in the Evolv Shift X supports up to 5 meters of LED strips. This allows you to expand your RGB lighting with any of our RGB products. Choose to control manually with a single button or connect the RGB controller to your motherboard with the adapter cable.

PHANTEKS LED strips

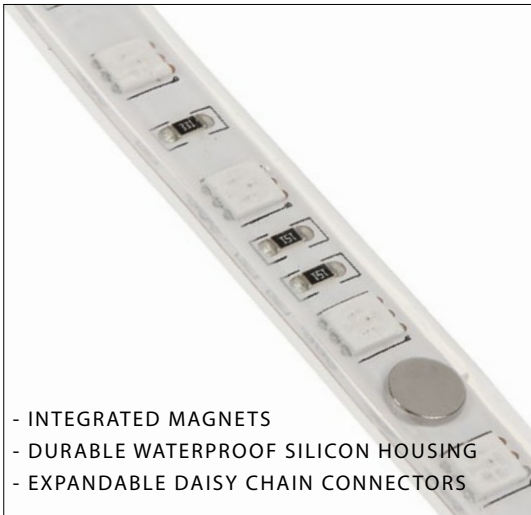

- INTEGRATED MAGNETS
- DURABLE WATERPROOF SILICON HOUSING
- EXPANDABLE DAISY CHAIN CONNECTORS

PHANTEKS RGB Waterblocks



CONTACT US

As a Phanteks customer, you are priority number one. We have a dedicated team of employees across the globe working hard every day to make sure we deliver the superior experience you deserve. We are here for you. If you have a question or a concern about our products, we have numerous ways you can reach us. Please choose one most convenient for you to connect with our team.

CUSTOMER CARE

RMA and Technical Support

Hours : Monday-Friday 9:00-5:00 PST

Global Regions:

rma@phanteks.com

support@phanteks.com

North America and South America:

Phone number : +1(909)598-2115

support@phanteksusa.com

WARRANTY

PHANTEKS warrants its products to be free from defects in material and workmanship during the warranty period; when given normal, proper and intended usage. If a product proves to be defective in material or workmanship during the warranty period, PHANTEKS will, at its sole option, repair or replace the product with same product or similar product. The replacement product assumes the remaining warranty of the original product or 30 days, whichever provides longer coverage for the customer.

Duration of warranty:

1. FANS - 5 years
2. I/O Port - 2 years
3. LED On/Off Switch - 2 years
4. Chassis - 5 years
5. Front and Top Panels - 5 years

Please check www.phanteks.com/Warranty for more information.

PIANTEKS

PHANTEKS