

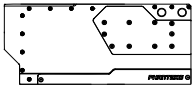

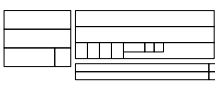

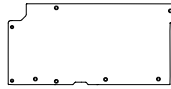



# GLACIER G40 GIGABYTE GPU BLOCK

INSTALLATION GUIDE V1.0

PH-GB4090GB\_BK01/CR01/MW01\_BP



## PACKAGE CONTENTS

	<b>GB4090GB block</b> QTY: 1		<b>Block thermal pads</b> QTY: 3 pre-cut pieces		<b>GB4090GB backplate</b> QTY: 1
	<b>GLACIER stop fitting</b> QTY: 2		<b>M2.5x8 flush screws</b> QTY: 6		<b>Backplate thermal pads</b> QTY: 1 pre-cut pieces
	<b>M2.5x5 screws/washers</b> QTY: 6/6		<b>M2.5x6 flush screws</b> QTY: 2		<b>Thermal compound</b> QTY: 1
	<b>Phanteks D-RGB cable</b> QTY: 1		<b>Motherboard cable</b> QTY: 1		

**⚠ WARNING** – This product is intended for advanced users. Improper installation may result in damage to your equipment. While all efforts have been made to provide the most comprehensive information possible, Phanteks assumes no liability expressed or implied for any damage(s) occurring to your components as a result of using Phanteks cooling products, either due to mistake or omission on our part in the below instructions, or due to failure or defect in the Phanteks cooling products. Do not disassemble the water block. Warranty will be voided.

## STEP 1. REMOVING STOCK COOLER

Unscrew all highlighted screws to remove the stock cooler and backplate.

-  backplate screws
-  stock cooler screws

**⚠** Make sure to unplug the LED and Fan cables when you remove the stock cooler.

### GIGABYTE RTX 4090 GAMING OC

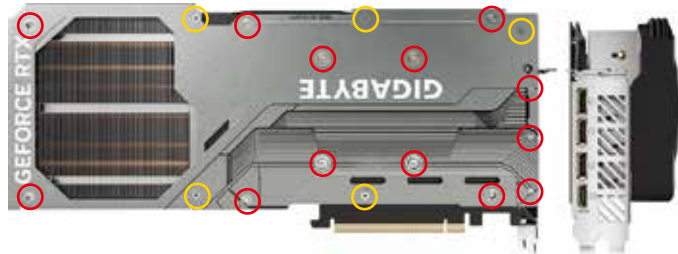

### GIGABYTE RTX 4090 MASTER

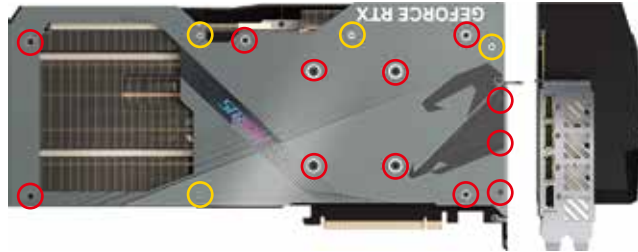

## STEP 2. APPLYING THERMAL PASTE & PADS

Clean off the original thermal compound. We recommend using isopropanol alcohol.

Remove the protective film and place the the thermal pads on the correct position on the PCB.

Apply the Phanteks Thermal Compound to the center of the GPU chip.

**⚠** Make sure to remove the protective film on both sides of the thermal pads.

### GIGABYTE RTX 4090 GAMING OC / AORUS MASTER

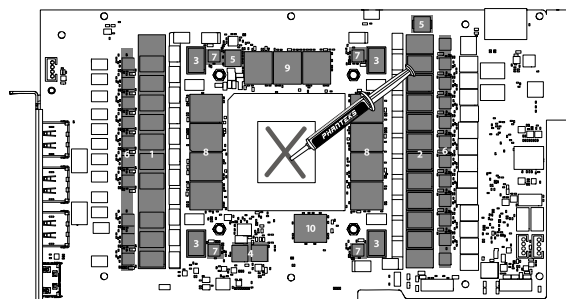

1			8	
2			8	
3	3	3	4	5
6			7	7
6			7	7

### STEP 3. MOUNT THE WATER BLOCK

Secure the support bracket to the GPU block first.

Carefully position the water block onto the graphics card. Align the mounting holes on the PCB with the holes on the water block.

Secure the water block with 6 M2.5x5mm screws and washers to the PCB.

Secure the Support Bracket with the original cooler screw.

 **Make sure to lay the GPU with the water block flat down without resting on the PCI bracket.**

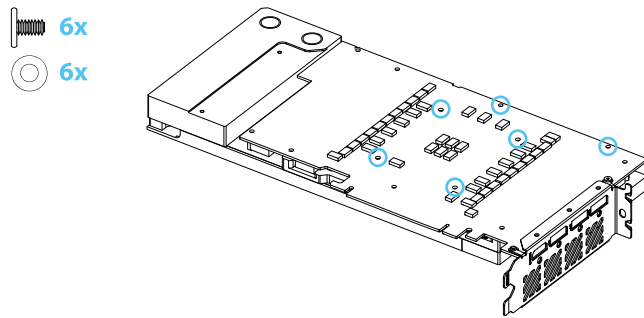
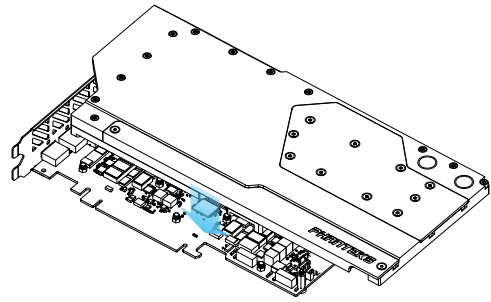

### STEP 4. APPLYING THERMAL PADS

Remove the protective film on both sides and place the thermal pads on the correct position on the backplate.

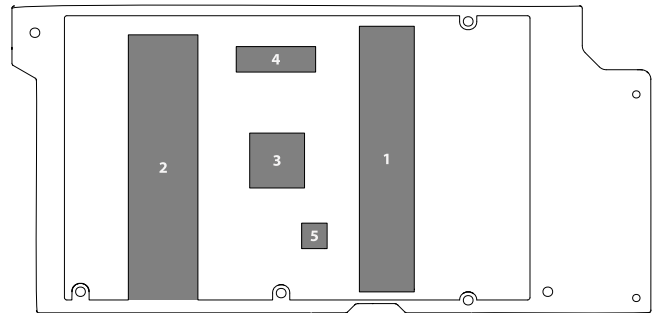
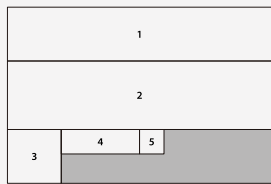

### STEP 5. INSTALL THE BACKPLATE

Carefully position the backplate onto the graphics card. Align the mounting holes on the PCB with the holes on the backplate.

Secure the backplate with 6x M2.5x8mm and 2x M2.5x6mm flush screws to the PCB.

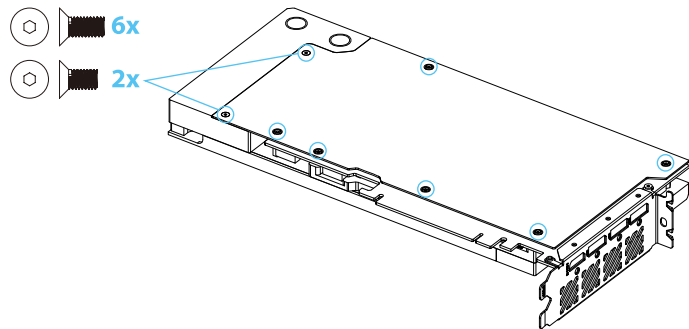

### STEP 6. INSTALL INTO THE SYSTEM

1. Connect the D-RGB cable to the D-RGB strip in the water block.

 **All Phanteks D-RGB products can be daisy-chained together.**

2. Install the GPU into the system.

3. Install the waterloop and Stop Fittings.

 **Always perform a leak test before providing power to any system components.**

