

THIS MANUAL IS FOR THE FOLLOWING MODELS

Dieses Handbuch gilt für die folgenden Modelle | Ce manuel concerne les modèles suivants | Este manual es para los siguientes modelos | 此手册适用于以下型号

PH-F120M25_G2_BBK01'	(_3P)	M25-120 Gen2 Black
PH-F120M25_G2_DBK01	(_3P)	M25-120 Gen2 D-RGB Black
PH-F120M25_G2_DWT01	(_3P)	M25-120 Gen2 D-RGB White
PH-F120M25R_G2_DBK01	(_3P)	M25-120 Gen2 D-RGB Black
PH-F120M25R_G2_DWT01	(_3P)	M25-120 Gen2 D-RGB White
PH-F140M25_G2_BBK01'	(_3P)	M25-140 Gen2 Black
PH-F140M25_G2_DBK01	(_3P)	M25-140 Gen2 D-RGB Black
PH-F140M25_G2_DWT01	(_3P)	M25-140 Gen2 D-RGB White
PH-F140M25R_G2_DBK01	(_3P)	M25-140 Gen2 D-RGB Black
PH-F140M25R_G2_DWT01	(_3P)	M25-140 Gen2 D-RGB White

- EN** Phanteks will not take responsibility for any damages incurred due to incorrect installation or usage of this product.
- DE** Phanteks übernimmt keine Verantwortung für Schäden, die durch eine falsche Installation oder Verwendung dieses Produkts entstehen.
- FR** Phanteks décline toute responsabilité en cas de dommages résultant d'une installation ou d'une utilisation incorrecte de ce produit.
- ES** Phanteks no se responsabilizará de los daños ocasionados por la instalación o el uso incorrectos de este producto.
- CN** Phanteks 不会对安装中失误造成的任何损失负责, 请仔细阅读本手册。



Online Manual
Online-Handbuch
Manuel en ligne
Manual en línea
在线手册

SCOPE OF DELIVERY¹

Lieferumfang | Contenu de la livraison | Alcance de la entrega | 产品内容物

 Fan Screw Single Pack x5 Triple Pack x14	 LINQ6 Extension Cable 500 mm Single Pack x1 Triple Pack x2	 Screw Covers Left (Bridge) / Right Single Pack x2 x2 x2 Triple Pack x4 x4 x4
 M25 Gen2 Single Pack x1 Triple Pack x3	 LINQ6 Mainboard Adapter 500 mm Single Pack - Triple Pack x1	<p>*NOTE: NON-DRGB MODEL CABLES</p> PWM Extension Cable 500 mm Single Pack x1 Triple Pack x2

1. CONNECT MULTIPLE FANS

Verbinden Sie mehrere Lüfter | Connectez plusieurs ventilateurs | Conecte varios ventiladores | 连接多个风扇

01 TAKE CABLES OUT OF FRAME

Kabel aus dem Rahmen nehmen | Retirez les câbles du cadre | Saque los cables del marco | 将电缆从框架中取出

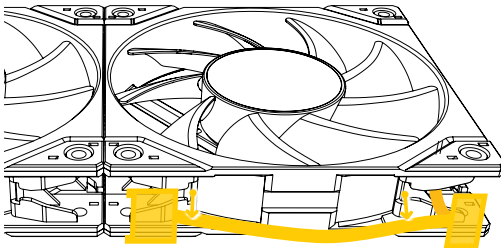

02 SLIDE AND SECURE MULTIPLE FANS

Schieben und sichern Sie mehrere Lüfter | Faites glisser et sécurisez plusieurs ventilateurs | Deslice y asegure varios ventiladores | 滑动并固定多个风扇

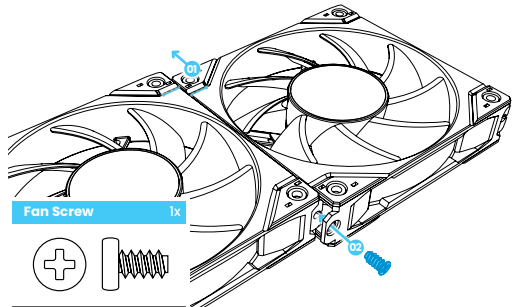

03 CONNECT LINQ6 CABLE

LINQ6-Kabel anschließen | Connectez le câble LINQ6 | Conecte el cable LINQ6 | 连接 LINQ6 电缆

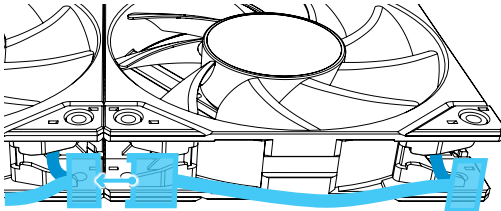

LINQ6 Cable

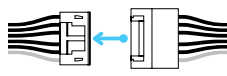

04 PLACE CABLES INTO FRAME

Kabel im Rahmen platzieren | Placez les câbles dans le cadre | Coloque los cables en el marco | 将电缆放入框架

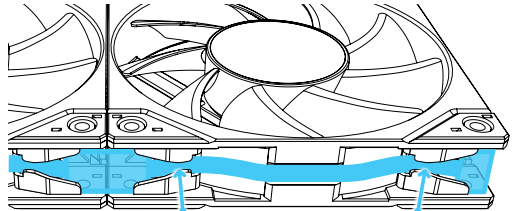

Gently push the LINQ6 cable in between the cable channel.

Schieben Sie das LINQ6-Kabel vorsichtig zwischen den Kabelkanälen.
Poussez doucement le câble LINQ6 entre le canal de câble.
Empuje suavemente el cable LINQ6 entre el canal del cable.
将 LINQ6 电缆轻轻推入电缆通道之间。

2. CONNECT FAN CABLE

D-RGB-Kabel | Cables D-RVB | Cables D-RGB | D-RGB 线材

LINQ6 FAN CABLE

Lüfterkabel anschließen | Connectez le câble du ventilateur | Conecte el cable del ventilador | 连接风扇电缆

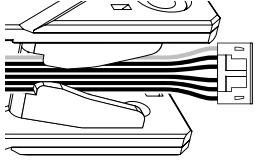

LINQ6 EXTENSION CABLE

LINQ6-Erweiterung | Extension LINQ6 | Extensión LINQ6 | LINQ6 延长线



Glacier One
M25 Gen2

D-RGB LIGHT DIRECTION

LINQ6-Erweiterung | Extension LINQ6 | Extensión LINQ6 | LINQ6 延长线

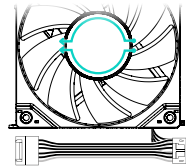

The D-RGB light direction starts from the connector side on the fan.
Die Richtung des D-RGB-Lichts beginnt auf der Anschlussseite des Lüfters.
La direction de la lumière D-RGB commence du côté du connecteur sur le ventilateur.
La dirección de la luz D-RGB comienza desde el lado del conector del ventilador.
D-RGB 灯光方向从风扇上的连接器侧开始。

OPTIONAL: LINQ6 MAINBOARD ADAPTER

Optional: D-RGB LINQ6-Adapter | En option: adaptateur D-RGB LINQ6 | Opcional: Adaptador D-RGB LINQ6 | 可选项: D-RGB LINQ6 转接线

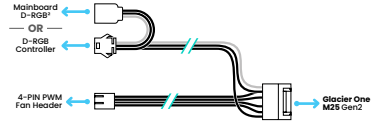

IMPORTANCE NOTICE

Follow mainboard manual for instructions on D-RGB control.
Befolgen Sie für Anweisungen zur D-RGB-Steuerung das Motherboard-Handbuch.
Suivez le manuel de la carte mère pour obtenir des instructions sur le contrôle D-RGB.
Siga el manual de la placa base para obtener instrucciones sobre el control D-RGB.
按照主板手册了解 D-RGB 控制说明。

CONTROLLER IS NEEDED FOR D-RGB FUNCTIONS

Für D-RGB-Funktionen ist ein Controller erforderlich.
Un contrôleur est nécessaire pour les fonctions D-RGB.
Se necesita un controlador para las funciones D-RGB.
D-RGB 需要控制器以使用 D-RGB 功能。

3. INSTALL SCREW COVERS

Installieren Sie Lüfterabdeckungen | Installer les couvercles de ventilateur | Instalar cubiertas de ventilador | 安装风扇罩

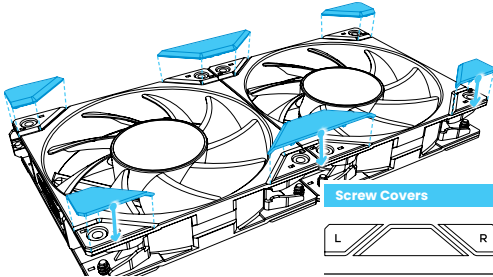

Screw Covers



REGULAR | REVERSE AIRFLOW

Normaler oder umgekehrter Luftstrom | Flux d'air régulier ou inversé | Flujo de aire regular o inverso | 常规或反向气流

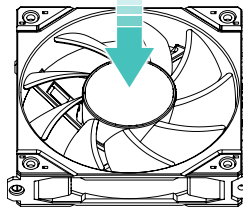

REGULAR MODELS

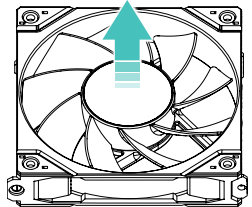

REVERSE MODELS

SAFETY INFORMATION

SICHERHEITSMITTEILUNG | INFORMATION DE SÉCURITÉ | INFORMACIÓN DE SEGURIDAD | 安全信息

In order to achieve maximum safety, we suggest that you adopt the following guidelines:

- Place the product on a clean and stable surface that allows adequate air ventilation.
- Don't use or place the product and any of its components near water, moisture, or other wet surfaces; or place the product near any heat, open flame, or other hot surfaces such as radiators, stoves, fireplaces, and candles.
- Use caution when operating the desktop PC to avoid electrical shock or damage, such as unplugging the power supply during thunderstorms, ensuring that your hands are dry before using (and handling) the desktop PC, keeping it away from any source of liquid and/or heat source, and using all other reasonable precautions needed under the circumstances.
- When connecting external devices to your desktop PC, carefully plan how the wires will be placed. Protect any connected cables from being trod on or pinched, particularly at plugs, convenience receptacles, or the point where they exit from.
- Take extra caution when handling/removing/reattaching glass components. Once removed, place the glass component on a stable surface first before proceeding.
- When unplugging any connected devices and/or cables, always pull the cable or device's plug or connector. Don't forcefully tug on its cord.
- Don't place any heavy items on top of the product.
- Make sure that the desktop PC is off, unplugged from the outlet, and that all connected devices are powered off and unplugged (if any) before installing or uninstalling any internal component to and/or from the desktop PC or product.

NOTE ON DISPOSAL



The WEEE symbol indicates that this product must not be disposed of with normal household waste. Through the correct disposal of this product, you will help protect the environment. For more information on the disposal of this product, please contact your local municipality, your waste disposal service or the shop where you purchased the product.

Phanteks Taiwan Inc.

11F, No. 150, Jian 1st Rd,
Zhonghe Dist.
New Taipei City 235

Importer EU

Axpertec int. B.V. (EU)
Sydneystraat 33
3047 BP Rotterdam
The Netherlands

Importer US

Axpertec Inc. (US)
20465 E Walnut Dr. N
City of Industry, CA 91789
USA



FR
Cet appareil se recycle



Points de collecte sur www.quefairemedesdechets.fr
Privilegiez la réparation ou le don de votre appareil!

LEGEND

Legende | Legenda | 说明

- Remove | Entfernen | Retirer | Eliminar | 移除
- Install | Installieren | Installer | Instalar | 安装
- Loosen | Lösen | Desserrer | Aflojar | 拧松